



Éxito a través del Servicio

KIMEX PET S.A. DE C.V.

KM. 26.5 AUTOPISTA MEXICO-QUERETARO

APARTADO POSTAL No. 168 TLALNEPANTLA,

ESTADO DE MEXICO, C.P. 54020 MEXICO

TELS: 53-66-90-00



### PET PREFORM SPECIFICATIONS SHEET

DATE: Feb 12 th, 16

REFERENCE: PRE-KX-01

MADE BY: PET LABORATORY

REV: "0"

## TECHNICAL SHEET: 50/3 CORVAGLIA PREFORM

**PREFORM:** 50/3

**FINISH:** CORVAGLIA

**COLOR:** WITHOUT COLOR, PIGMENTED, CLEAR, OR OPAQUE

**COMPOSITION:** PET RESIN (POLYETHYLENE TEREPHTHALATE) WITH OR WITHOUT PIGMENT

**INTENDED USE:** MANUFACTURE OF PACKAGING

**PACKING:** GAYLORD CONTAINER (CARTON BULK BOX), STRAPPED AND LABELED, POLYETHYLENE INNER LINER.

**PIECES PER BOX:** 5,808

**STORAGE:** DO NOT EXPOSE THE BOX TO MOISTURE, UV RAYS, AVOID BRUSH MOVEMENTS  
KEEP IN CLEAN PLACE, WITHOUT DUST.

**QUALITY LABORATORY TESTS:** WEIGHT, DIMENSIONAL ANALYSIS, ACETALDEHYDE AND INTRINSEC VISCOSITY.

### DIMENSIONS:

No.	CHARACTERISTIC	UNITS	SPECIFICATIONS	
			MIN	MAX
1	WEIGHT	g	50.56	51.16
2	CONTROL DIAMETER AT TOP OF FINISH	mm	21.63	21.89
3	THREAD ROOT DIAMETER	mm	24.35	24.65
4	THREAD CREST DIAMETER	mm	27.22	27.48
5	TAMPER EVIDENT BEAD DIAMETER	mm	27.82	28.12
6	SUPPORT LEDGE DIAMETER	mm	31.80	32.20
7	HEIGHT FROM SUPPORT LEDGE	mm	16.55	17.05
8	THICKNESS 1	mm	3.50	3.76
9	THICKNESS 2	mm	3.50	3.76
10	THICKNESS 3	mm	3.50	3.76
11	THICKNESS 4	mm	3.50	3.76
12	TOTAL PREFORM HEIGHT	mm	152.10	152.50

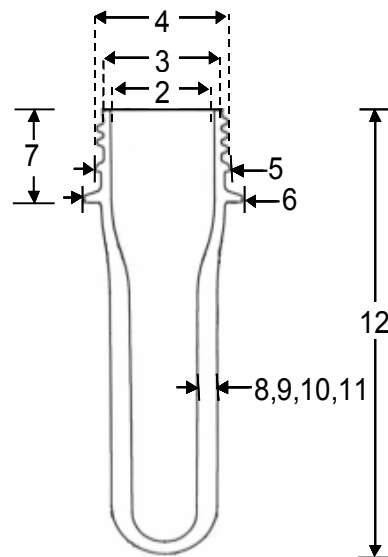

NOTE: THICKNESS 1, 2, 3 Y 4 ARE 90° EACH OTHER.  
HEIGHT FROM SUPPORT LEDGE = HEIGHT OF FINISH