



Éxito a través del Servicio

KIMEX PET S.A. DE C.V.

KM. 26.5 AUTOPISTA MEXICO-QUERETARO

APARTADO POSTAL No. 168 TLALNEPANTLA,

ESTADO DE MEXICO, C.P. 54020 MEXICO

TELS: 53-66-90-00



PET PREFORM SPECIFICATIONS SHEET

DATE: Feb 12 th, 16

REFERENCE: PRE-KX-01

MADE BY: PET LABORATORY

REV: "0"

TECHNICAL SHEET: 57 CORVAGLIA PREFORM

PREFORM: 57	FINISH: CORVAGLIA	COLOR: WITHOUT COLOR, PIGMENTED, CLEAR, OR OPAQUE
COMPOSITION:	PET RESIN (POLYETHYLENE TEREPHTHALATE) WITH OR WITHOUT PIGMENT	
INTENDED USE:	MANUFACTURE OF PACKAGING	
PACKING:	GAYLORD CONTAINER (CARTON BULK BOX), STRAPPED AND LABELED, POLYETHYLENE INNER LINER.	PIECES PER BOX: 5,808
STORAGE:	DO NOT EXPOSE THE BOX TO MOISTURE, UV RAYS, AVOID BRUSH MOVEMENTS KEEP IN CLEAN PLACE, WITHOUT DUST.	

QUALITY LABORATORY TESTS: WEIGHT, DIMENSIONAL ANALYSIS, ACETALDEHYDE AND INTRINSEC VISCOSITY.

DIMENSIONS:

No.	CHARACTERISTIC	UNITS	SPECIFICATIONS	
			MIN	MAX
1	WEIGHT	g	56.70	57.30
2	CONTROL DIAMETER AT TOP OF FINISH	mm	21.63	21.89
3	THREAD ROOT DIAMETER	mm	24.35	24.65
4	THREAD CREST DIAMETER	mm	27.22	27.48
5	TAMPER EVIDENT BEAD DIAMETER	mm	27.82	28.12
6	SUPPORT LEDGE DIAMETER	mm	31.80	32.20
7	HEIGHT FROM SUPPORT LEDGE	mm	16.55	17.05
8	THICKNESS 1	mm	4.14	4.40
9	THICKNESS 2	mm	4.14	4.40
10	THICKNESS 3	mm	4.14	4.40
11	THICKNESS 4	mm	4.14	4.40
12	TOTAL PREFORM HEIGHT	mm	152.10	152.50

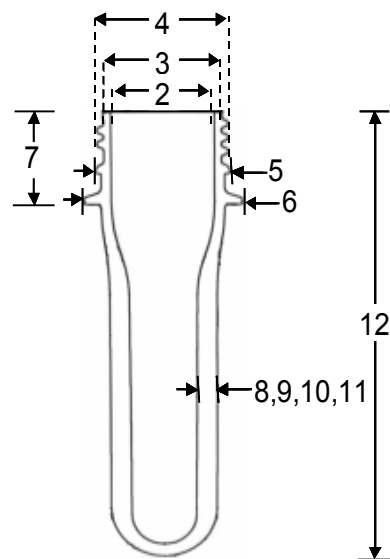

NOTE: THICKNESS 1, 2, 3 Y 4 ARE 90° EACH OTHER.
HEIGHT FROM SUPPORT LEDGE = HEIGHT OF FINISH