



PET PREFORM
SPECIFICATIONS SHEET

DATE: Feb 12 th, 16
REFERENCE: PRE-KX-01
MADE BY: PET LABORATORY
REV: "0"

TECHNICAL SHEET: 21/3 PCO 1816 PREFORM

PREFORM: 21/3	FINISH: PCO 1816	COLOR: WITHOUT COLOR, PIGMENTED, CLEAR, OR OPAQUE
COMPOSITION:	PET RESIN (POLYETHYLENE TEREPHTHALATE) WITH OR WITHOUT PIGMENT	
INTENDED USE:	MANUFACTURE OF PACKAGING	
PACKING:	GAYLORD CONTAINER (CARTON BULK BOX), STRAPPED AND LABELED, POLYETHYLENE INNER LINER.	PIECES PER BOX: 13,392
STORAGE:	DO NOT EXPOSE THE BOX TO MOISTURE, UV RAYS, AVOID BRUSH MOVEMENTS KEEP IN CLEAN PLACE, WITHOUT DUST.	

QUALITY LABORATORY TESTS: WEIGHT, DIMENSIONAL ANALYSIS, ACETALDEHYDE AND INTRINSEC VISCOSITY.

DIMENSIONS:

No.	CHARACTERISTIC	UNITS	SPECIFICATIONS	
			MIN	MAX
1	WEIGHT	g	21.00	21.60
2	CONTROL DIAMETER AT TOP OF FINISH	mm	21.61	21.87
3	THREAD ROOT DIAMETER	mm	24.36	24.66
4	THREAD CREST DIAMETER	mm	27.30	27.56
5	TAMPER EVIDENT BEAD DIAMETER	mm	27.84	28.10
6	SUPPORT LEDGE DIAMETER	mm	32.62	33.38
7	HEIGHT FROM SUPPORT LEDGE	mm	21.00	21.40
8	THICKNESS 1	mm	2.37	2.63
9	THICKNESS 2	mm	2.37	2.63
10	THICKNESS 3	mm	2.37	2.63
11	THICKNESS 4	mm	2.37	2.63
12	TOTAL PREFORM HEIGHT	mm	97.67	98.07

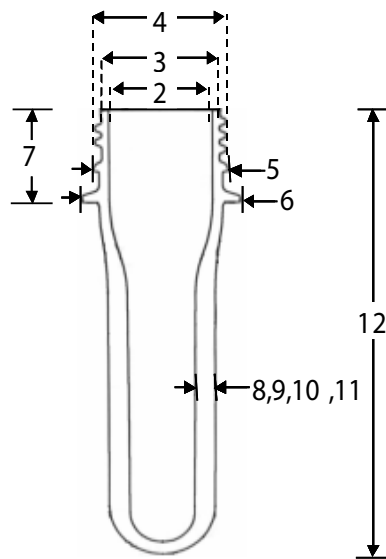

NOTE: THICKNESS 1, 2, 3 AND 4 ARE 90° EACH OTHER.
HEIGHT FROM SUPPORT LEDGE = HEIGHT OF FINISH