



Éxito a través del Servicio

KIMEX PET S.A. DE C.V.

KM. 26.5 AUTOPISTA MEXICO-QUERETARO

APARTADO POSTAL No. 168 TLALNEPANTLA,

ESTADO DE MEXICO, C.P. 54020 MEXICO

TELS: 53-66-90-00



### PET PREFORM SPECIFICATIONS SHEET

DATE: Feb 12 th, 17

REFERENCE: PRE-KX-01

MADE BY: PET LABORATORY

REV: "O"

## TECHNICAL SHEET: 20.5 PCO 1881 PREFORM

**PREFORM:** 20.5

**FINISH:** PCO 1881

**COLOR:** WITHOUT COLOR, PIGMENTED, CLEAR, OR OPAQUE

**COMPOSITION:**

PET RESIN (POLYETHYLENE TEREPHTHALATE) WITH OR WITHOUT PIGMENT

**INTENDED USE:**

MANUFACTURE OF PACKAGING

**PACKING:**

GAYLORD CONTAINER (CARTON BULK BOX), STRAPPED AND LABELED, POLYETHYLENE INNER LINER.

**PIECES PER BOX:** 12,816

**STORAGE:**

DO NOT EXPOSE THE BOX TO MOISTURE, UV RAYS, AVOID BRUSH MOVEMENTS KEEP IN CLEAN PLACE, WITHOUT DUST.

**QUALITY LABORATORY TESTS:**

WEIGHT, DIMENSIONAL ANALYSIS, ACETALDEHYDE AND INTRINSEC VISCOSITY.

### DIMENSIONS:

No.	CHARACTERISTIC	UNITS	SPECIFICATIONS	
			MIN	MAX
1	WEIGHT	g	20.50	21.60
2	CONTROL DIAMETER AT TOP OF FINISH	mm	21.61	21.87
3	THREAD ROOT DIAMETER	mm	24.07	24.33
4	THREAD CREST DIAMETER	mm	27.27	27.53
5	TAMPER EVIDENT BEAD DIAMETER	mm	27.85	28.15
6	SUPPORT LEDGE DIAMETER	mm	32.85	33.15
7	HEIGHT FROM SUPPORT LEDGE	mm	16.75	17.25
8	THICKNESS 1	mm	2.37	2.63
9	THICKNESS 2	mm	2.37	2.63
10	THICKNESS 3	mm	2.37	2.63
11	THICKNESS 4	mm	2.37	2.63
12	TOTAL PREFORM HEIGHT	mm	97.67	98.07

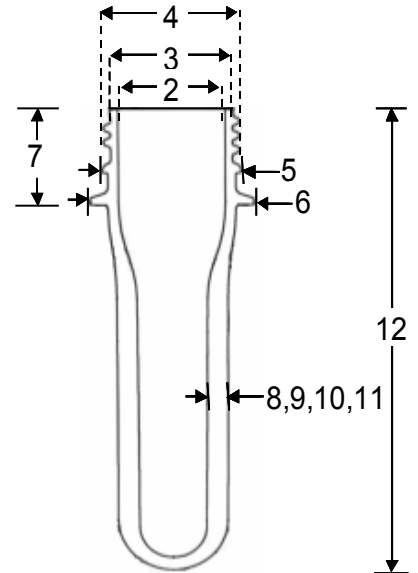

NOTE: THICKNESS 1, 2, 3 Y 4 ARE 90° EACH OTHER.  
HEIGHT FROM SUPPORT LEDGE = HEIGHT OF FINISH